

Molecular BioSystems

www.molecularbiosystems.org

RSC Publishing is a not-for-profit publisher and a division of the Royal Society of Chemistry. Any surplus made is used to support charitable activities aimed at advancing the chemical sciences. Full details are available from www.rsc.org

IN THIS ISSUE

ISSN 1742-206X CODEN MBOIBW 4(10) 957-1032 (2008)

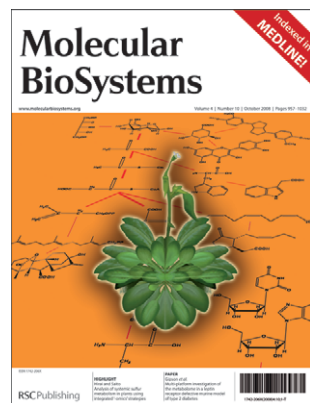

Cover

See Hirai and Saito pp. 967-973. The image shows *Arabidopsis thaliana* against a background of various intermediates involved in sulfur metabolism in this organism, investigated using integrated -omics strategies. Image reproduced by permission of Masami Yokota Hirai and Kazuki Saito from *Mol. BioSyst.*, 2008, 4, 967.

CHEMICAL BIOLOGY

B73

Drawing together the research highlights and news from all RSC publications, *Chemical Biology* provides a 'snapshot' of the latest developments in chemical biology, showcasing newsworthy articles and significant scientific advances.

Chemical Biology

October 2008/Volume 3/Issue 10

www.rsc.org/chembiology

HIGHLIGHTS

967

Analysis of systemic sulfur metabolism in plants using integrated '-omics' strategies

Masami Yokota Hirai* and Kazuki Saito*

Sulfur metabolism in plants yields various sulfur-containing compounds that play pivotal roles in many aspects of life. This highlight describes recent advances in '-omic' studies that have led to an understanding of gene-metabolite networks and an identification of the function of the genes involved in sulfur metabolism.

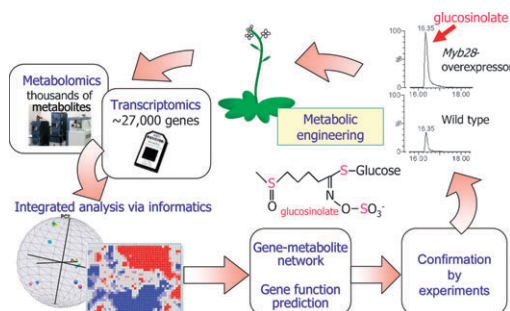

974

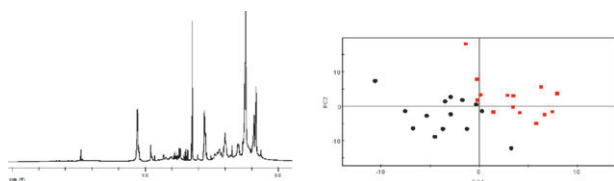

Contributions from metabolomics to fish research

Linda M. Samuelsson* and D. G. Joakim Larsson

This highlight summarises and evaluates the information obtained from the application of metabolomics in fish research and discusses its potential in the future.

980



Recent developments in environmental metabolomics

Mark R. Viant*

Metabolomics is increasingly being used to characterise the interactions of organisms with their natural environment. This article describes the latest developments in this vibrant field.

987

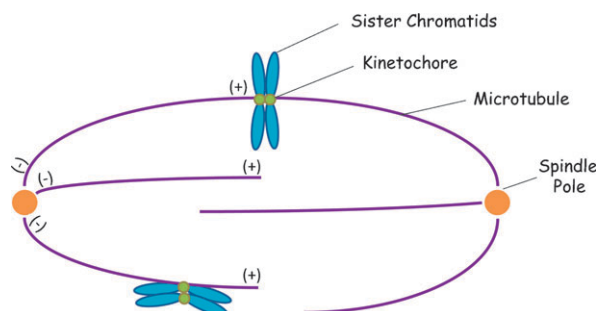

Kinetochores assembly: building a molecular machine that drives chromosome movement

Jianhui Yao and Xiangwei He*

Kinetochores play crucial roles in mediating chromosome segregation. Major progress has been made in recent years in identifying their biochemical composition, the assembly patterns and the mechanisms of their functions.

993

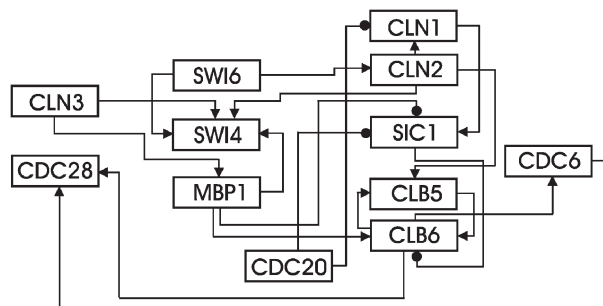

Computational models reconstruct gene regulatory networks

Anastasios Bezerianos and Ioannis A. Maraziotis*

This paper provides a brief summary of some of the most recent and promising computational models and mathematical frameworks used to reconstruct, model and infer gene regulatory networks from gene expression data.

1001

Reciprocal chemical genetics for swift lead and target identification

Coenraad Kuijl, Adriaan W. Tuin, Hermen Overkleef and Jacques Neeffjes*

Reciprocal chemical genetics: correlation between chemical profile of *in vivo* phenotypes and *in vitro* data of potential target genes leads to swift target identification.

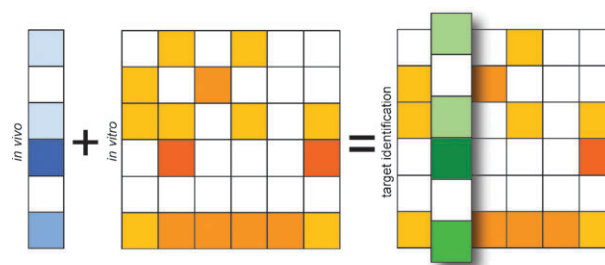

1009

Reversing cells and oscillating motility proteins

Simone Leonardy, Iryna Bulyha and Lotte Søgaard-Anderson*

When cells of *M. xanthus* move on a surface they periodically reverse their direction of movement. At the molecular level, reversals involve oscillations of motility proteins between the cell poles. This review summarizes the understanding of how motility proteins are targeted to the poles and oscillations regulated.

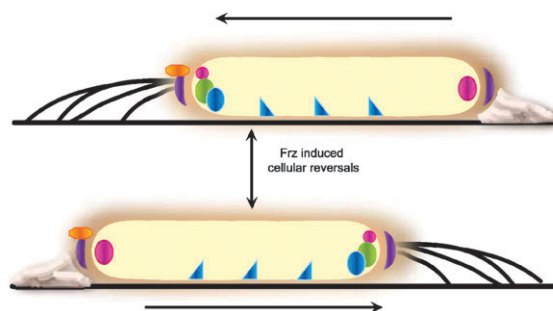

PAPERS

1015

Multi-platform investigation of the metabolome in a leptin receptor defective murine model of type 2 diabetes

Geoffrey T. Gipson,* Kay S. Tatsuoka, Rachel J. Ball, Bahrad A. Sokhansanj, Michael K. Hansen, Terence E. Ryan, Mark P. Hodson, Brian C. Sweatman and Susan C. Connor

Several urinary metabolites associated with diabetic mice are found in NMR and LC-MS data. Findings from NMR, LC-MS, and microarray data highlight a number of processes associated with diabetes and reveal tissue specific responses.

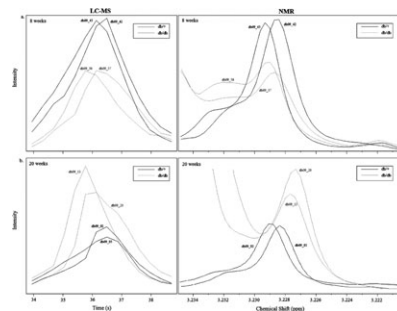

1024

Inferring Boolean networks with perturbation from sparse gene expression data: a general model applied to the interferon regulatory network

Le Yu,* Steven Watterson,* Stephen Marshall and Peter Ghazal

We propose an algorithm for inferring biologically meaningful Boolean network descriptions of steady state pathway behaviour from sampled microarray data. This gives us a computational representation of transcriptional regulatory networks.

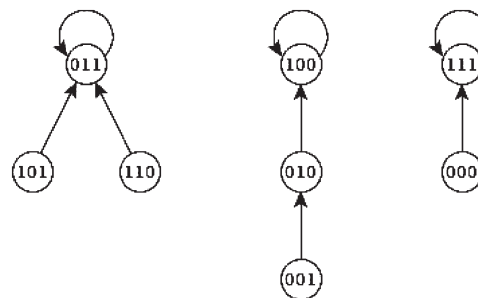

Molecular BioSystems

Indexed in
MEDLINE!

High quality research at the interface between chemistry, the -omic sciences and systems biology

Leading researchers in the field support our journal . . .



"Chemists will increasingly turn to '-omics' approaches to understand mechanism of action and specificity of bioactive molecules. Molecular BioSystems provides a home for this rapidly developing interdisciplinary science."

Thomas Kodadek,
Chair, Editorial Board

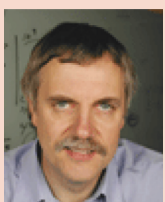

"This is a very respectable impact factor for a new journal. Authors can be confident that their work is visible to the appropriate audience."

Ruedi Aebersold,
Former Editorial Board member

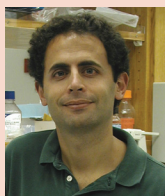

"Congratulations on the excellent start – I am sure this [impact factor] number will continue to rise over the coming years."

Benjamin Cravatt,
Editorial Board member



"We received three excellent, tractable, and critical reviews with a rapid turn around time after submitting our manuscript. In today's world of potentially long times from submission to publication, this was very refreshing."

Mike Washburn
Advisory Board Member



"We believe Molecular BioSystems has more to offer the chemical biology community than any other journal."

Michael Smith,
Commissioning Editor

Submit your next paper to *Molecular BioSystems* and benefit from:

- Enhanced HTML articles with RSC Prospect
 - Hyperlinked compound information, including downloadable structures in text.
 - Gene, Sequence and Cell Ontology terms linked to definitions and related articles
 - IUPAC Gold Book terms linked
- Impact factor 4.121*
- Fast Publication times (average 80 days from receipt)

010879

*2007 Thompson Scientific (ISI) Journal Citation Reports

RSC Publishing

www.molecularbiosystems.org

Registered Charity Number 207890